

MC14070B, MC14077B

CMOS SSI

Quad Exclusive “OR” and “NOR” Gates

The MC14070B quad exclusive OR gate and the MC14077B quad exclusive NOR gate are constructed with MOS P-channel and N-channel enhancement mode devices in a single monolithic structure. These complementary MOS logic gates find primary use where low power dissipation and/or high noise immunity is desired.

Features

- Supply Voltage Range = 3.0 Vdc to 18 Vdc
- All Outputs Buffered
- Capable of Driving Two Low-Power TTL Loads or One Low-Power Schottky TTL Load Over the Rated Temperature Range
- Double Diode Protection on All Inputs
- MC14070B – Replacement for CD4030B and CD4070B Types
- MC14077B – Replacement for CD4077B Type
- Pb-Free Packages are Available*

MAXIMUM RATINGS (Voltages Referenced to V_{SS})

| Symbol | Parameter | Value | Unit |
|-------------------|---|------------------------|------|
| V_{DD} | DC Supply Voltage Range | -0.5 to +18.0 | V |
| V_{in}, V_{out} | Input or Output Voltage Range (DC or Transient) | -0.5 to $V_{DD} + 0.5$ | V |
| I_{in}, I_{out} | Input or Output Current (DC or Transient) per Pin | ± 10 | mA |
| P_D | Power Dissipation, per Package (Note 1) | 500 | mW |
| T_A | Ambient Temperature Range | -55 to +125 | °C |
| T_{stg} | Storage Temperature Range | -65 to +150 | °C |
| T_L | Lead Temperature (8-Second Soldering) | 260 | °C |

Maximum ratings are those values beyond which device damage can occur. Maximum ratings applied to the device are individual stress limit values (not normal operating conditions) and are not valid simultaneously. If these limits are exceeded, device functional operation is not implied, damage may occur and reliability may be affected.

1. Temperature Derating:

Plastic “P and D/DW” Packages: - 7.0 mW/°C From 65°C To 125°C

This device contains protection circuitry to guard against damage due to high static voltages or electric fields. However, precautions must be taken to avoid applications of any voltage higher than maximum rated voltages to this high-impedance circuit. For proper operation, V_{in} and V_{out} should be constrained to the range $V_{SS} \leq (V_{in} \text{ or } V_{out}) \leq V_{DD}$.

Unused inputs must always be tied to an appropriate logic voltage level (e.g., either V_{SS} or V_{DD}). Unused outputs must be left open.

*For additional information on our Pb-Free strategy and soldering details, please download the ON Semiconductor Soldering and Mounting Techniques Reference Manual, SOLDERRM/D.



ON Semiconductor®

<http://onsemi.com>

MARKING DIAGRAMS

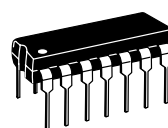

PDIP-14
P SUFFIX
CASE 646

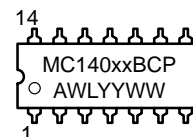

SOIC-14
D SUFFIX
CASE 751A

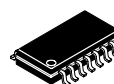
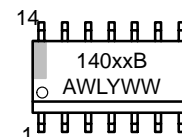

SOEIAJ-14
F SUFFIX
CASE 965

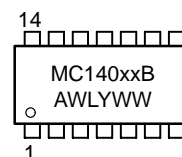

xx = Specific Device Code
A = Assembly Location
WL, L = Wafer Lot
YY, Y = Year
WW, W = Work Week

ORDERING INFORMATION

See detailed ordering and shipping information in the package dimensions section on page 3 of this data sheet.

MC14070B, MC14077B

PIN ASSIGNMENT

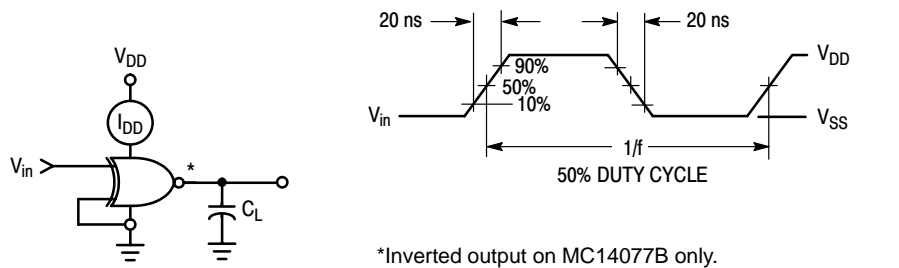
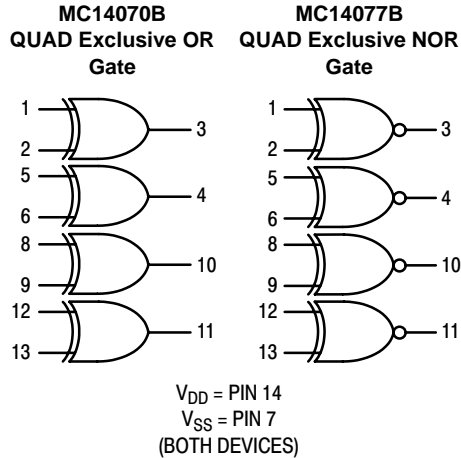
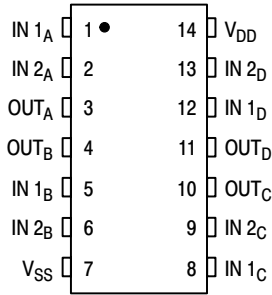

Figure 1. Power Dissipation Test Circuit and Waveform

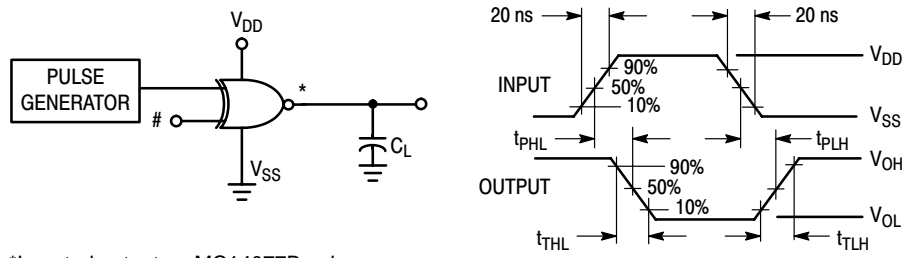

Figure 2. Switching Time Test Circuit and Waveforms

MC14070B, MC14077B

ORDERING INFORMATION

| Device | Package | Shipping† |
|--------------|----------------------|--------------------------|
| MC14070BCP | PDIP-14 | 500 Units / Rail |
| MC14070BCPG | PDIP-14 (Pb-Free) | 500 Units / Rail |
| MC14070BD | SOIC-14 | 55 Units / Rail |
| MC14070BDG | SOIC-14 (Pb-Free) | 55 Units / Rail |
| MC14070BDR2 | SOIC-14 | 2500 Units / Tape & Reel |
| MC14070BDR2G | SOIC-14 (Pb-Free) | 2500 Units / Tape & Reel |
| MC14070BFEL | SOEIAJ-14 | 2000 Units / Tape & Reel |
| | | |
| MC14077BCP | PDIP-14 | 500 Units / Rail |
| MC14077BCPG | PDIP-14 (Pb-Free) | 500 Units / Rail |
| MC14077BD | SOIC-14 | 55 Units / Rail |
| MC14077BDR2 | SOIC-14 | 2500 Units / Tape & Reel |
| MC14077BDR2G | SOIC-14 (Pb-Free) | 2500 Units / Tape & Reel |
| MC14077BFEL | SOEIAJ-14 | 2000 Units / Tape & Reel |

†For information on tape and reel specifications, including part orientation and tape sizes, please refer to our Tape and Reel Packaging Specifications Brochure, BRD8011/D.

MC14070B, MC14077B

ELECTRICAL CHARACTERISTICS (Voltages Referenced to V_{SS})

| Characteristic | Symbol | V_{DD} Vdc | - 55°C | | 25°C | | | 125°C | | Unit |
|---|---------------------------|-----------------|--|-----------|-------|-----------------|-----------|-------|-----------|-----------|
| | | | Min | Max | Min | Typ (Note 2) | Max | Min | Max | |
| Output Voltage $V_{in} = V_{DD}$ or 0 $V_{in} = 0$ or V_{DD} | "0" Level V_{OL} | 5.0 | - | 0.05 | - | 0 | 0.05 | - | 0.05 | Vdc |
| | | 10 | - | 0.05 | - | 0 | 0.05 | - | 0.05 | |
| | | 15 | - | 0.05 | - | 0 | 0.05 | - | 0.05 | |
| | "1" Level V_{OH} | 5.0 | 4.95 | - | 4.95 | 5.0 | - | 4.95 | - | Vdc |
| | | 10 | 9.95 | - | 9.95 | 10 | - | 9.95 | - | |
| | | 15 | 14.95 | - | 14.95 | 15 | - | 14.95 | - | |
| Input Voltage $(V_O = 4.5$ or 0.5 Vdc) $(V_O = 9.0$ or 1.0 Vdc) $(V_O = 13.5$ or 1.5 Vdc) $(V_O = 0.5$ or 4.5 Vdc) $(V_O = 1.0$ or 9.0 Vdc) $(V_O = 1.5$ or 13.5 Vdc) | "0" Level V_{IL} | 5.0 | - | 1.5 | - | 2.25 | 1.5 | - | 1.5 | Vdc |
| | | 10 | - | 3.0 | - | 4.50 | 3.0 | - | 3.0 | |
| | | 15 | - | 4.0 | - | 6.75 | 4.0 | - | 4.0 | |
| | "1" Level V_{IH} | 5.0 | 3.5 | - | 3.5 | 2.75 | - | 3.5 | - | Vdc |
| | | 10 | 7.0 | - | 7.0 | 5.50 | - | 7.0 | - | |
| | | 15 | 11 | - | 11 | 8.25 | - | 11 | - | |
| Output Drive Current $(V_{OH} = 2.5$ Vdc) $(V_{OH} = 4.6$ Vdc) $(V_{OH} = 9.5$ Vdc) $(V_{OH} = 13.5$ Vdc) $(V_{OL} = 0.4$ Vdc) $(V_{OL} = 0.5$ Vdc) $(V_{OL} = 1.5$ Vdc) | Source I_{OH} | 5.0 | -3.0 | - | -2.4 | -4.2 | - | -1.7 | - | mAdc |
| | | 5.0 | -0.64 | - | -0.51 | -0.88 | - | -0.36 | - | |
| | | 10 | -1.6 | - | -1.3 | -2.25 | - | -0.9 | - | |
| | | 15 | -4.2 | - | -3.4 | -8.8 | - | -2.4 | - | |
| | Sink I_{OL} | 5.0 | 0.64 | - | 0.51 | 0.88 | - | 0.36 | - | mAdc |
| | | 10 | 1.6 | - | 1.3 | 2.25 | - | 0.9 | - | |
| 15 | | 4.2 | - | 3.4 | 8.8 | - | 2.4 | - | | |
| Input Current | I_{in} | 15 | - | ± 0.1 | - | ± 0.00001 | ± 0.1 | - | ± 1.0 | μ Adc |
| Input Capacitance $(V_{in} = 0)$ | C_{in} | - | - | - | - | 5.0 | 7.5 | - | - | pF |
| Quiescent Current (Per Package) | I_{DD} | 5.0 | - | 0.25 | - | 0.0005 | 0.25 | - | 7.5 | μ Adc |
| | | 10 | - | 0.5 | - | 0.0010 | 0.5 | - | 15 | |
| | | 15 | - | 1.0 | - | 0.0015 | 1.0 | - | 30 | |
| Total Supply Current (Notes 3 & 4) (Dynamic plus Quiescent, Per Package) $(C_L = 50$ pF on all outputs, all buffers switching) | I_T | 5.0 10 15 | $I_T = (0.3 \mu\text{A/kHz}) f + I_{DD}$ $I_T = (0.6 \mu\text{A/kHz}) f + I_{DD}$ $I_T = (0.9 \mu\text{A/kHz}) f + I_{DD}$ | | | | | | | μ Adc |
| Output Rise and Fall Times (Note 3) $(C_L = 50$ pF) $t_{TLH}, t_{THL} = (1.35 \text{ ns/pF}) C_L + 33 \text{ ns}$ $t_{TLH}, t_{THL} = (0.60 \text{ ns/pF}) C_L + 20 \text{ ns}$ $t_{TLH}, t_{THL} = (0.40 \text{ ns/pF}) C_L + 20 \text{ ns}$ | $t_{TLH},$ t_{THL} | 5.0 | - | - | - | 100 | 200 | - | - | ns |
| | | 10 | - | - | - | 50 | 100 | - | - | |
| | | 15 | - | - | - | 40 | 80 | - | - | |
| | | | | | | | | | | |
| Propagation Delay Times (Note 3) $(C_L = 50$ pF) $t_{PLH}, t_{PHL} = (0.90 \text{ ns/pF}) C_L + 130 \text{ ns}$ $t_{PLH}, t_{PHL} = (0.36 \text{ ns/pF}) C_L + 57 \text{ ns}$ $t_{PLH}, t_{PHL} = (0.26 \text{ ns/pF}) C_L + 37 \text{ ns}$ | $t_{PLH},$ t_{PHL} | 5.0 | - | - | - | 175 | 350 | - | - | ns |
| | | 10 | - | - | - | 75 | 150 | - | - | |
| | | 15 | - | - | - | 55 | 110 | - | - | |
| | | | | | | | | | | |

2. Data labelled "Typ" is not to be used for design purposes but is intended as an indication of the IC's potential performance.

3. The formulas given are for the typical characteristics only at 25°C.

4. To calculate total supply current at loads other than 50 pF:

$$I_T(C_L) = I_T(50 \text{ pF}) + (C_L - 50) Vfk$$

where: I_T is in μ H (per package), C_L in pF, $V = (V_{DD} - V_{SS})$ in volts, f in kHz is input frequency, and $k = 0.002$.

MC14070B, MC14077B

PACKAGE DIMENSIONS

PDIP-14
P SUFFIX
CASE 646-06
ISSUE N

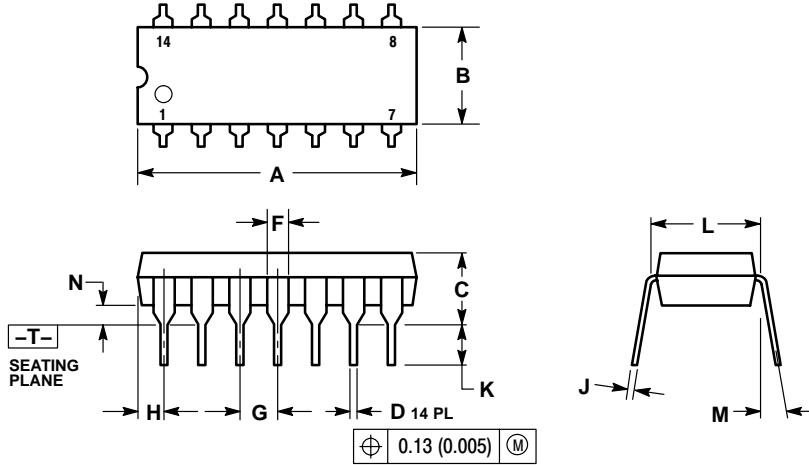

NOTES:

1. DIMENSIONING AND TOLERANCING PER ANSI Y14.5M, 1982.
2. CONTROLLING DIMENSION: INCH.
3. DIMENSION L TO CENTER OF LEADS WHEN FORMED PARALLEL.
4. DIMENSION B DOES NOT INCLUDE MOLD FLASH.
5. ROUNDED CORNERS OPTIONAL.

| DIM | INCHES | | MILLIMETERS | |
|-----|-----------|-------|-------------|-------|
| | MIN | MAX | MIN | MAX |
| A | 0.715 | 0.770 | 18.16 | 18.80 |
| B | 0.240 | 0.260 | 6.10 | 6.60 |
| C | 0.145 | 0.185 | 3.69 | 4.69 |
| D | 0.015 | 0.021 | 0.38 | 0.53 |
| F | 0.040 | 0.070 | 1.02 | 1.78 |
| G | 0.100 BSC | | 2.54 BSC | |
| H | 0.052 | 0.095 | 1.32 | 2.41 |
| J | 0.008 | 0.015 | 0.20 | 0.38 |
| K | 0.115 | 0.135 | 2.92 | 3.43 |
| L | 0.290 | 0.310 | 7.37 | 7.87 |
| M | 10° | | 10° | |
| N | 0.015 | 0.039 | 0.38 | 1.01 |

SOIC-14
D SUFFIX
CASE 751A-03
ISSUE G

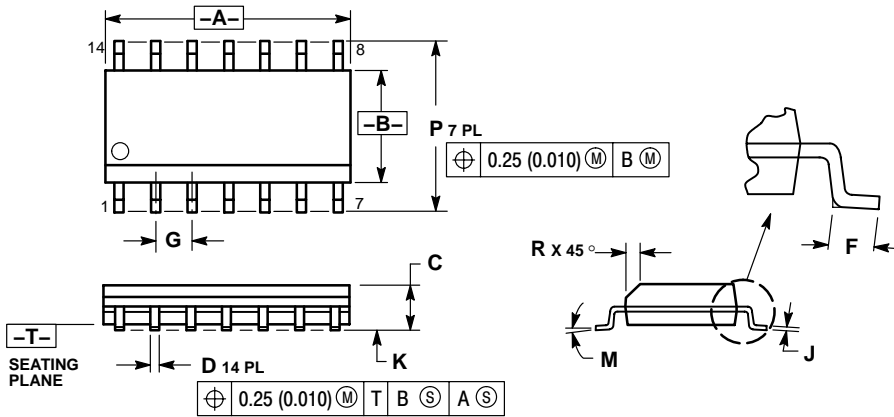

NOTES:

1. DIMENSIONING AND TOLERANCING PER ANSI Y14.5M, 1982.
2. CONTROLLING DIMENSION: MILLIMETER.
3. DIMENSIONS A AND B DO NOT INCLUDE MOLD PROTRUSION.
4. MAXIMUM MOLD PROTRUSION 0.15 (0.006) PER SIDE.
5. DIMENSION D DOES NOT INCLUDE DAMBAR PROTRUSION. ALLOWABLE DAMBAR PROTRUSION SHALL BE 0.127 (0.005) TOTAL IN EXCESS OF THE D DIMENSION AT MAXIMUM MATERIAL CONDITION.

| DIM | MILLIMETERS | | INCHES | |
|-----|-------------|------|-----------|-------|
| | MIN | MAX | MIN | MAX |
| A | 8.55 | 8.75 | 0.337 | 0.344 |
| B | 3.80 | 4.00 | 0.150 | 0.157 |
| C | 1.35 | 1.75 | 0.054 | 0.068 |
| D | 0.35 | 0.49 | 0.014 | 0.019 |
| F | 0.40 | 1.25 | 0.016 | 0.049 |
| G | 1.27 BSC | | 0.050 BSC | |
| J | 0.19 | 0.25 | 0.008 | 0.009 |
| K | 0.10 | 0.25 | 0.004 | 0.009 |
| M | 0° 7° | | 0° 7° | |
| P | 5.80 | 6.20 | 0.228 | 0.244 |
| R | 0.25 | 0.50 | 0.010 | 0.019 |

MC14070B, MC14077B

PACKAGE DIMENSIONS

SOEIAJ-14 F SUFFIX CASE 965-01 ISSUE O

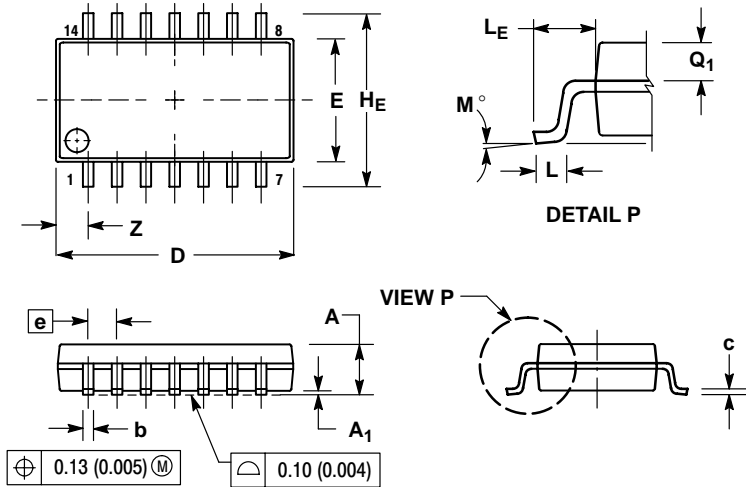

NOTES:

- 1 DIMENSIONING AND TOLERANCING PER ANSI Y14.5M, 1982.
- 2 CONTROLLING DIMENSION: MILLIMETER.
- 3 DIMENSIONS D AND E DO NOT INCLUDE MOLD FLASH OR PROTRUSIONS AND ARE MEASURED AT THE PARTING LINE. MOLD FLASH OR PROTRUSIONS SHALL NOT EXCEED 0.15 (0.006) PER SIDE.
- 4 TERMINAL NUMBERS ARE SHOWN FOR REFERENCE ONLY.
- 5 THE LEAD WIDTH DIMENSION (b) DOES NOT INCLUDE DAMBAR PROTRUSION. ALLOWABLE DAMBAR PROTRUSION SHALL BE 0.08 (0.003) TOTAL IN EXCESS OF THE LEAD WIDTH DIMENSION AT MAXIMUM MATERIAL CONDITION. DAMBAR CANNOT BE LOCATED ON THE LOWER RADIUS OR THE FOOT. MINIMUM SPACE BETWEEN PROTRUSIONS AND ADJACENT LEAD TO BE 0.46 (0.018).

| DIM | MILLIMETERS | | INCHES | |
|----------------|-------------|-------|-----------|-------|
| | MIN | MAX | MIN | MAX |
| A | --- | 2.05 | --- | 0.081 |
| A ₁ | 0.05 | 0.20 | 0.002 | 0.008 |
| b | 0.35 | 0.50 | 0.014 | 0.020 |
| c | 0.18 | 0.27 | 0.007 | 0.011 |
| D | 9.90 | 10.50 | 0.390 | 0.413 |
| E | 5.10 | 5.45 | 0.201 | 0.215 |
| e | 1.27 BSC | | 0.050 BSC | |
| H _E | 7.40 | 8.20 | 0.291 | 0.323 |
| 0.50 | 0.50 | 0.85 | 0.020 | 0.033 |
| L _E | 1.10 | 1.50 | 0.043 | 0.059 |
| M | 0 ° | 10 ° | 0 ° | 10 ° |
| Q ₁ | 0.70 | 0.90 | 0.028 | 0.035 |
| Z | --- | 1.42 | --- | 0.056 |

ON Semiconductor and are registered trademarks of Semiconductor Components Industries, LLC (SCILLC). SCILLC reserves the right to make changes without further notice to any products herein. SCILLC makes no warranty, representation or guarantee regarding the suitability of its products for any particular purpose, nor does SCILLC assume any liability arising out of the application or use of any product or circuit, and specifically disclaims any and all liability, including without limitation special, consequential or incidental damages. "Typical" parameters which may be provided in SCILLC data sheets and/or specifications can and do vary in different applications and actual performance may vary over time. All operating parameters, including "Typicals" must be validated for each customer application by customer's technical experts. SCILLC does not convey any license under its patent rights nor the rights of others. SCILLC products are not designed, intended, or authorized for use as components in systems intended for surgical implant into the body, or other applications intended to support or sustain life, or for any other application in which the failure of the SCILLC product could create a situation where personal injury or death may occur. Should Buyer purchase or use SCILLC products for any such unintended or unauthorized application, Buyer shall indemnify and hold SCILLC and its officers, employees, subsidiaries, affiliates, and distributors harmless against all claims, costs, damages, and expenses, and reasonable attorney fees arising out of, directly or indirectly, any claim of personal injury or death associated with such unintended or unauthorized use, even if such claim alleges that SCILLC was negligent regarding the design or manufacture of the part. SCILLC is an Equal Opportunity/Affirmative Action Employer. This literature is subject to all applicable copyright laws and is not for resale in any manner.

PUBLICATION ORDERING INFORMATION

LITERATURE FULFILLMENT:

Literature Distribution Center for ON Semiconductor
P.O. Box 61312, Phoenix, Arizona 85082-1312 USA
Phone: 480-829-7710 or 800-344-3860 Toll Free USA/Canada
Fax: 480-829-7709 or 800-344-3867 Toll Free USA/Canada
Email: orderlit@onsemi.com

N. American Technical Support: 800-282-9855 Toll Free
USA/Canada

Japan: ON Semiconductor, Japan Customer Focus Center
2-9-1 Kamimeguro, Meguro-ku, Tokyo, Japan 153-0051
Phone: 81-3-5773-3850

ON Semiconductor Website: <http://onsemi.com>

Order Literature: <http://www.onsemi.com/litorder>

For additional information, please contact your local Sales Representative.